

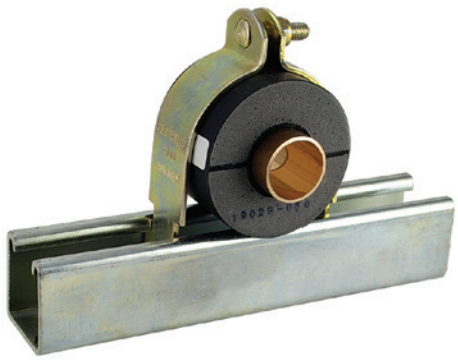



Cush-A-Therm® vs. Plastic Insulation Clamps

Cush-A-Therm®	Plastic Alternative
	
<ul style="list-style-type: none"> • Prevents Condensation Leaks: Saves Ceilings, Walls, Supports • No Air Gaps, No Energy Transfer • Maintains Thermal Vapor Barrier • Self-Extinguishing - ASTM D 635 • Temperature Range: -70°F to 250°F • Hermetically Sealed, Crush Resistant Cushion • UV Resistance Rated Excellent - ASTM G7 • Cushion Made from Polyurethane Foam Laminated with a Rubber Lining • Maximum Vibration Protection • Thoroughly Supports Pipe and Tube • Easily Wraps Around Pipe or Tube • Stainless Steel Clamps Available 	<ul style="list-style-type: none"> • Sweats with Condensation: Ruins Ceilings, Walls, Supports • Air Gaps allow Energy Transfer • Does NOT Maintain a Thermal Vapor Barrier; Allowing Rust to Develop • Smokes, Melts and Drips if Fire Tested • Temperature Range: -60°F to 225°F • Minimal Protection Against Vibration • Must Be Cut to Install
<p>Insulation Glued to Cush-A-Therm which Avoids Air Space and Loss of Insulation</p>  <p>Pipe Insulation</p> <p>Cush-A-Therm</p> <p>Pipe Insulation</p> <p>Only Insulation Contacts Pipe no Thermal Conductor</p>	<p>Air Space (loss of insulation)</p>  <p>Pipe Insulation</p> <p>Plastic Connector</p> <p>Plastic Connector is Thermal Conductor</p>

Call ZSi-Foster at **(800) 323-7053** or order now at ZSi-Foster.com

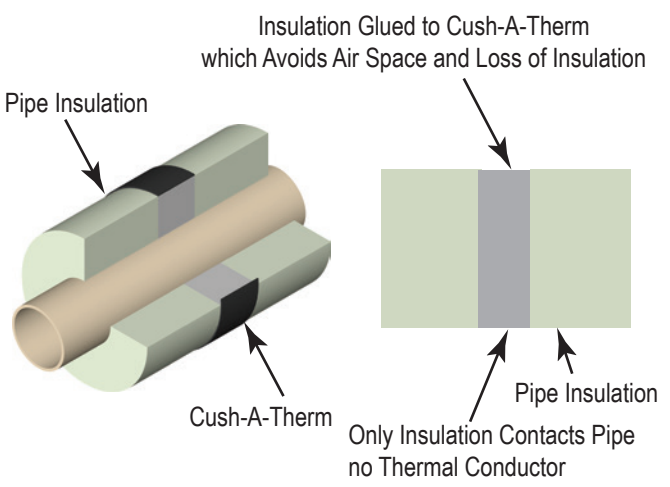
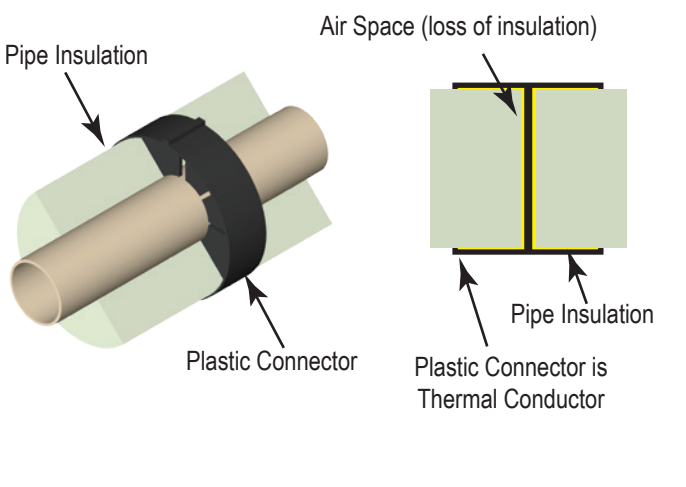

Cush-A-Therm[®] Insulation Clamp Protects the Vapor Barrier

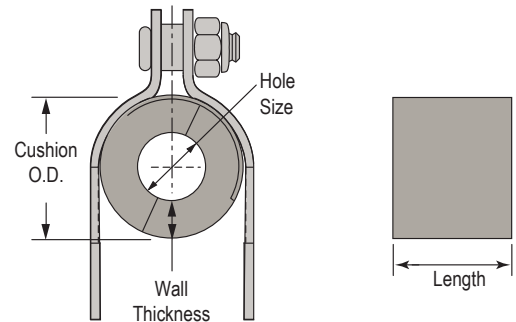
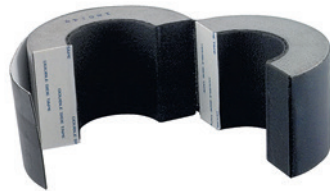
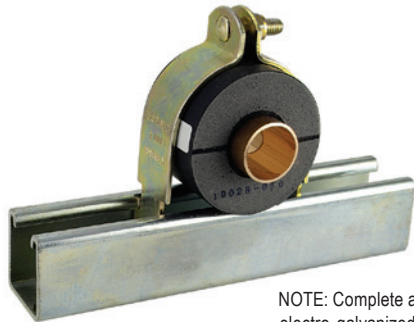

NOTE: Complete assembly supplied with gold electro-galvanized channel clamp and hardware

Cush-A-Therm Insulation Clamp provides a crush-resistant airtight seal for chilled refrigeration or mechanical pipe lines that require continuous insulation.

The rigid foam construction has an insulating tape inner lining which supports tube and absorbs vibration of operating pipe lines.

The outer cover consists of a special rubber coating which seals the cushion after installation in order to prevent condensation.

Its strong closed-cell structure is ideal for liquid cooling lines to prevent condensation, save energy, and maintain the vapor barrier.

Stainless steel type 304 or 316 strut clamps are available.

Features:

- Temperature range: -70°F to +250°F (-200°C to +125°C)
- Flammability is Self-Extinguishing as tested under ASTM D 635
- Maintains thermal barrier protection
- Prevents condensation
- Properly supports pipe and tube
- Absorbs vibration
- Polyurethane foam laminated with a rubber lining

Dimensions (Inches)					Nominal 1/2" Wall Thickness		Nominal 3/4" Wall Thickness		Nominal 1" Wall Thickness		Nominal 1-1/2" Wall Thickness		Nominal 2" Wall Thickness	
Hole Size	Copper I.D.	Pipe O.D.	IPS	Len.	Part No.	Cushion O.D.	Part No.	Cushion O.D.	Part No.	Cushion O.D.	Part No.	Cushion O.D.	Part No.	Cushion O.D.
1/4	-	1/4	-	2.953"	UX1412	1 1/4 (1.250")	UX1434	1 3/4 (1.750")	UX1410	2 1/4 (2.250")	UX1415	3 1/4 (3.250")	-	-
3/8	1/4	3/8	-	2.953"	UX3812	1 3/8 (1.375")	UX3834	1 7/8 (1.875")	UX3810	2 3/8 (2.375")	UX3815	3 3/8 (3.375")	-	-
1/2	3/8	1/2	1/4	2.953"	UX1212	1 1/2 (1.500")	UX1234	2 (2.000")	UX1210	2 1/2 (2.500")	UX1215	3 1/2 (3.500")	-	-
5/8	1/2	5/8	3/8	2.953"	UX5812	1 5/8 (1.625")	UX5834	2 1/8 (2.125")	UX5810	2 5/8 (2.625")	UX5815	3 5/8 (3.625")	UX5820	4 5/8 (4.625")
3/4	5/8	3/4	-	2.953"	UX3412	1 3/4 (1.750")	UX3434	2 1/4 (2.250")	UX3410	2 3/4 (2.750")	UX3415	3 3/4 (3.750")	UX3420	4 3/4 (4.750")
7/8	3/4	7/8	1/2	2.953"	UX7812	1 7/8 (1.875")	UX7834	2 3/8 (2.375")	UX7810	2 7/8 (2.875")	UX7815	3 7/8 (3.875")	UX7820	4 7/8 (4.875")
1-1/8	1	1 1/8	3/4	2.953"	UX11812	2 1/8 (2.125")	UX11834	2 5/8 (2.625")	UX11810	3 1/8 (3.125")	UX11815	4 1/8 (4.125")	UX11820	5 1/8 (5.125")
1-3/8	1 1/4	1 3/8	1	2.953"	UX13812	2 3/8 (2.375")	UX13834	2 7/8 (2.875")	UX13810	3 3/8 (3.375")	UX13815	4 3/8 (4.375")	UX13820	5 3/8 (5.375")
1-5/8	1 1/2	1 5/8	1 1/4	2.953"	UX15812	2 5/8 (2.625")	UX15834	3 1/8 (3.125")	UX15810	3 5/8 (3.625")	UX15815	4 5/8 (4.625")	UX15820	5 5/8 (5.625")
1-7/8	-	1 7/8	-	2.953"	UX17812	2 7/8 (2.875")	UX17834	3 3/8 (3.375")	UX17810	3 7/8 (3.875")	UX17815	4 7/8 (4.875")	UX17820	5 7/8 (5.875")
2-1/8	2	2 1/8	-	2.953"	UX21812	3 1/8 (3.125")	UX21834	3 5/8 (3.625")	UX21810	4 1/8 (4.125")	UX21815	5 1/8 (5.125")	UX21820	6 1/8 (6.125")
2-3/8	2 1/4	2 3/8	2	2.953"	UX23812	3 3/8 (3.375")	UX23834	3 7/8 (3.875")	UX23810	4 3/8 (4.375")	UX23815	5 3/8 (5.375")	UX23820	6 3/8 (6.375")
2-5/8	2 1/2	2 5/8	-	3.937"	UX25812	3 5/8 (3.625")	UX25834	4 1/8 (4.125")	UX25810	4 5/8 (4.625")	UX25815	5 5/8 (5.625")	UX25820	6 5/8 (6.625")
2-7/8	-	2 7/8	2 1/2	3.937"	UX27812	3 7/8 (3.875")	UX27834	4 3/8 (4.375")	UX27810	4 7/8 (4.875")	UX27815	5 7/8 (5.875")	UX27820	6 7/8 (6.875")
3-1/8	3	3 1/8	-	3.937"	UX31812	4 1/8 (4.125")	UX31834	4 5/8 (4.625")	UX31810	5 1/8 (5.125")	UX31815	6 1/8 (6.125")	UX31820	7 1/8 (7.125")
3-1/2	-	3 1/2	3	3.937"	UX31212	4 1/2 (4.500")	UX31234	5 (5.000")	UX31210	5 1/2 (5.500")	UX31215	6 1/2 (6.500")	UX31220	7 1/2 (7.500")
3-5/8	3 1/2	3 5/8	-	3.937"	UX35812	4 5/8 (4.625")	UX35834	5 1/8 (5.125")	UX35810	5 5/8 (5.625")	UX35815	6 5/8 (6.625")	UX35820	7 5/8 (7.625")
4-1/8	4	4 1/8	3 1/2	3.937"	UX41812	5 1/8 (5.125")	UX41834	5 5/8 (5.625")	UX41810	6 1/8 (6.125")	UX41815	7 1/8 (7.125")	UX41820	8 1/8 (8.125")

Call ZSi-Foster at (800) 323-7053 or order now at ZSi-Foster.com

ZSi-Foster - Canton, MI | La Mirada, CA | Ocala, FL | Springfield, MO